

Juntas Universales



Lovejoy Pin & Block and Needle Bearing Industrial U-Joints

Lovejoy has been manufacturing industrial universal joints for over 45 years. Our industrial universal joint product line is well established and provides you with a wide range of standard and specialized products. The shape of the yoke is a special feature which results in exceptionally high strength, yet allows full, free movement of the joint. This accounts for the high horsepower capacity at high speeds.

Features and Benefits

- Industry standard
- Stainless steel and needle bearing available
- 13 sizes
- Pin & Block design
- Boot retaining grooves standard

D Type

This standard industrial-type universal joint with pin & block design is ideal for applications up to 25° and speeds to 1750 RPM.

HD Type

A high quality universal joint made to exacting tolerances, the HD will normally provide twice the life of a standard industrial-type universal joint

D303 Stainless

D type universal joints are available in stainless steel when contact with a corrosive atmosphere or sanitation requirements are a factor.

Needle Bearing Type

Designed with high quality, pre-lubricated, and sealed needle bearings, this universal joint provides the reliability necessary for speeds up to 6000 RPM and angles up to 25°.

LOJ and JR-4

These economical universal joints with offset pin design are ideal for use on hand operated, low torque drives. They are capable of operating angles to 45°.

DD and DDX Types

Designed with two Lovejoy standard D type universal joints and a center connecting shaft, the DD and DDX are tailored to your specific application requirements.

Multi-Spindle Type

Multi-spindle universal joint assemblies consist of two quality HD universal joints mounted at opposite ends of a spring loaded shaft. They are used to connect drill head drives to the drill spindles.

Universal Joint Boots

The life of a universal joint can be extended substantially if booted. Wear areas of the universal joint are protected from dirt and contaminants, while lubrication is retained.



D TYPE



HD TYPE



D STAINLESS



NEEDLE BEARING TYPE



LOJ TYPE

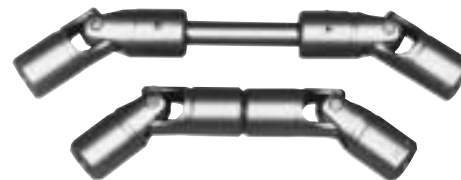

DD AND DDX TYPE



MULTI-SPINDLE TYPE



UNIVERSAL JOINT BOOT



WARNING

You must refer to page iv for Important Safety Instructions and Precautions for the selection and use of these products. Failure to follow the instructions and precautions can result in severe injury or death.

Pin & Block Type Selection Process

Steps in Selecting a Universal Joint

Determine the correct Universal joint size by working out the following calculations:

Step 1: Multiply revolutions per minute (RPM) by working angle.

Step 2: Determine the nominal torque of your application by using the following formulas:

$$\text{Nominal torque} = \text{in-lbs} = \frac{\text{HP} \times 63025}{\text{RPM}}$$

$$\text{Nm} = \frac{\text{KW} \times 9550}{\text{RPM}}$$

Step 3: Multiply the calculated torque by the desired service factor from the chart on page UJ-5.

Step 4: Refer to the running curves that apply to the desired U-joint. D and HD types use one curve, NB type another. For DD and DDX U-joints, use the curve that matches the U-joint being used. The required universal joint size can be determined by establishing the point of intersection of the RPM x Working Angle figure on the horizontal scale and the service factor torque of on the vertical scale. Size is stated against the curve immediately above this point.

Note: 1. U-joint life is extended by lubrication. Use boots to retain lubricant.

Selection Example

A U-joint is needed to transmit a torque load of 180 in-lbs operating at 1750 RPM. The working angle required is 5°, and the service factor is 2.

Step 1: RPM x Working Angle = 1750 x 5 = 8,750

Step 2: Nominal Torque = 180 in-lbs

Step 3: Service Factor x Torque = 2.0 x 180 = 360

Step 4: Find the point of the intersection of 360 in-lbs on the torque scale (vertical) and 8,750 on the RPM x Working Angle scale (horizontal), and the curve immediately above that point will indicate the correct U-joint size. The proper U-joint size is D-13 or HD-13 for longer life.

U-joint Type	U-joint Size	Max. Angle Offset	Max. Bore No Keyway Round		Max. Square/Hex Hole ³		Max. RPM	Static Breaking Torque	
			in	mm	in	mm		in-lbs	Nm
D-Type	D-1 to D-14	25°	2.00	50	1.38	35	1750	65,400	7,389
HD Type	D-1 to D-14	25°	2.00	50	1.38	35	1750	65,400	7,389
D Stainless	D4, 6, 8, 10, 12	25°	1.19	30	1.00	25	1750	10,400	1,175
Needle Bearing	D6, 8, 10, 12	25°	1.19	30	1.00	25	6000	10,500	1,186
LOJ	LOJ6, 8, 10	45°	See Data	—	See Data	—	—	3480	393
LOJ Jr.-4	JR-4	45°	See Data	—	See Data	—	—	180	20
Multi-spindle	D-1 to D-14	25°	2.00	50	1.38	35	1750	65,400	7,389

- Notes:**
1. Operation of all universal joints is determined by the angle/speed combinations of the application. Consult Lovejoy Engineering for specific limitations and recommendations.
 2. Applications that fall outside the limitations of these tables should be referred to our technical design staff.
 3. Square and hex bores are measured across the flats.



Running Curves D & HD Universal Joints

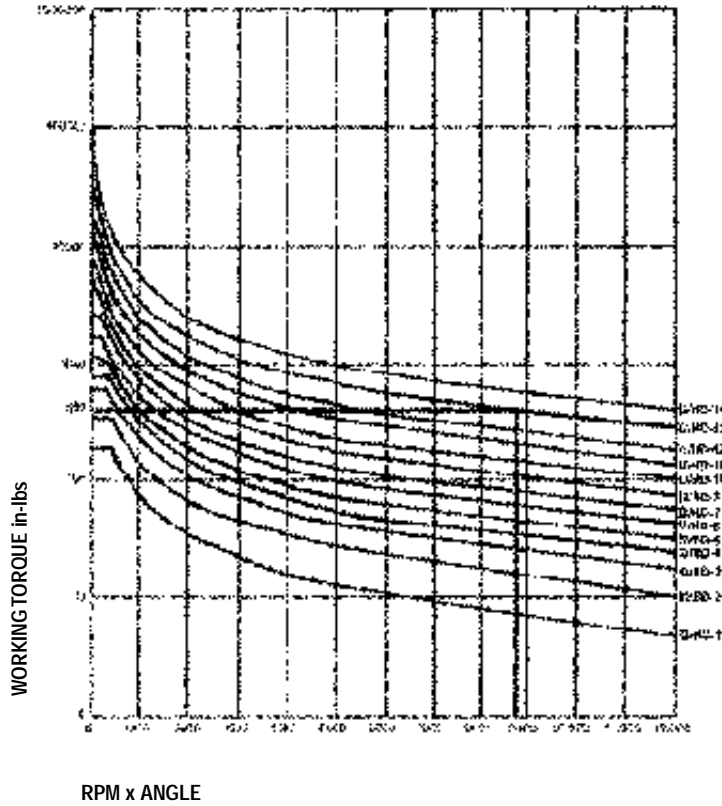

NB Universal Joints

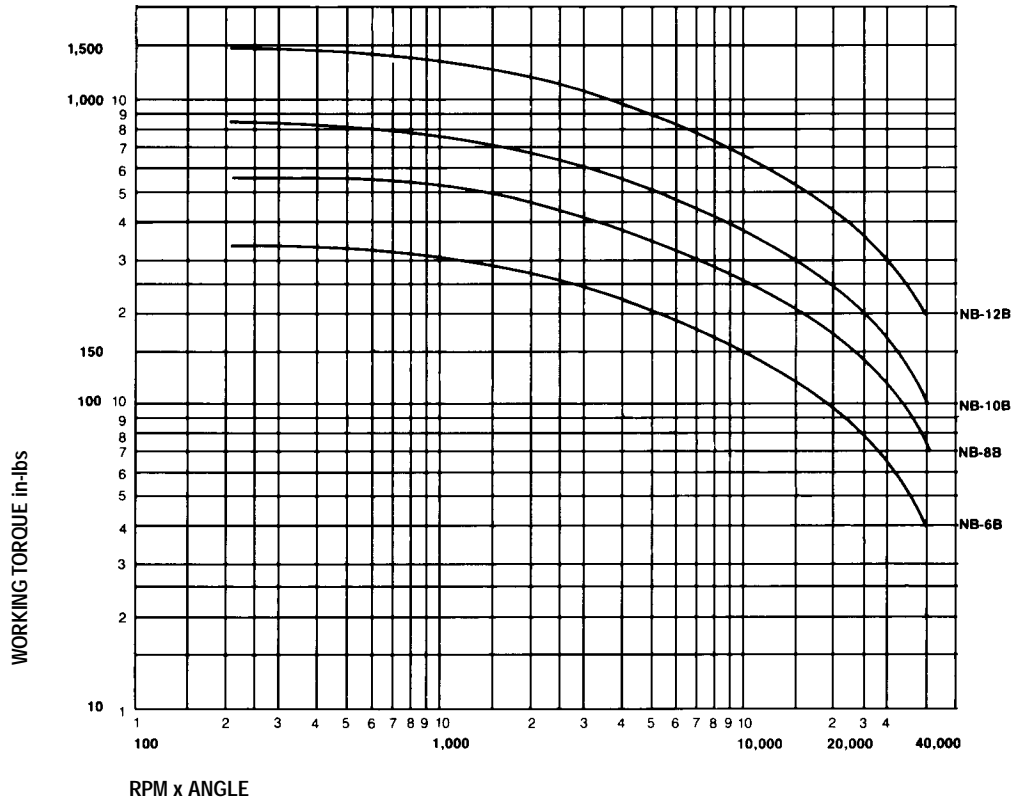

UJ

Application Service Factors

The values contained in the table should be used as a general guide. For above average shock loads or start/stop conditions of not more than once per hour, add .5 to the table value. Universal joints are not recommended for internal combustion engine applications. For severe shock loads or reversing loads, or start/stop conditions of more than once per hour, add 1 to the table value.

Agitators	Induced Draft w/o Damper Control2.00	Tumbling1.50
Pure Liquids1.25	Propellor1.50	Mixers
Liquids Variable1.25	Induced Draft w/Damper Control1.25	Concrete, Continuous1.75
Barge Puller2.00	Feeders	Muller1.50
Beaters1.50	Belt1.25	Paper Mills
Blowers	Screw1.25	Agitators (Mixers)1.25
Centrifugal1.25	Reciprocating2.50	Barker, Mechanical2.00
Lobe1.50	Generators	"Barking" Drum Spur Gear2.50
Vane1.50	Not Welding1.25	Beater & Pulper2.00
Can Filling Machinery1.25	Welding2.00	Calenders1.50
Car Dumpers2.50	Hoist1.50	Converting Machines1.25
Car Pullers1.50	Hammer Mills2.00	Conveyors1.25
Compressors	Kilns1.50	Dresses2.00
Centrifugal1.25	Laundry Washers	Dryers1.50
Lobe1.50	Reversing2.00	Jordans2.00
Reciprocatingnot recommended	Line Shafting	Log Haul2.00
Conveyors, Uniformly loaded or fed	Any Processing Mach1.50	Reel1.25
Assembly1.25	Lumber Machinery	Super Calenders1.50
Belt1.25	Barkers2.00	Winder1.25
Screw1.25	Edger Feed2.00	Printing Presses1.50
Bucket1.25	Live Rolls2.00	Pug Mill1.75
Live roll, shaker, and reciprocating3.00	Planer2.00	Pumps
Conveyors (Heavy Duty), Not uniformly fed	Slab Conveyor2.00	Centrifugal1.25
Assembly1.20	Machine Tools	Gear, Rotary, or Vane1.25
Belt1.20	Bending Roll2.00	Reciprocating
Oven1.20	Plate Planer2.00	1 cyl. single or double acting2.00
Reciprocating2.50	Punch Press Gear Driven2.00	2 cyl. single acting2.00
Screw1.20	Tapping Machinery2.00	2 cyl. double acting1.75
Shaker3.00	Other	3 or more cyl.1.50
Cranes & Hoists	Main Drive1.50	Rubber Machinery
Main Hoists2.00	Aux. Drives1.25	Mixer2.50
Reversing2.00	Metal Forming Machines	Rubber Calender2.00
Skip2.00	Draw Bench Carriage2.00	Screens
Trolley Drive2.00	Draw Bench Main Drive2.00	Air Washing1.25
Bridge Drive2.00	Extruder2.00	Rotary Stone or Gravel1.50
Slope2.00	Forming Machinery2.00	Vibrating2.50
Crushers	Slitters1.50	Water1.25
Ore3.00	Table Conveyors	Grizzly2.00
Stone3.00	Non-reversing2.50	Shredders1.50
Dredges	Reversing2.50	Steering Gearnot recommended
Cable Reels2.00	Wire Drawing2.00	Stokers1.25
Conveyors1.50	Wire Winding1.50	Textile Machinery
Cutter Head Drives2.50	Coilers1.50	Dryers1.25
Maneuvering Winches1.50	Mills, Rotary Type	Dyeing Mach.1.25
Pumps1.50	Ball2.00	Tumbling Barrel1.75
Evaporators	Cement Kilns2.00	Windlass2.00
Consult Factory1.25	Dryers, Coolers2.00	Woodworking Machinery1.50
Fans	Kilns2.00	
Centrifugal1.25	Pebble2.00	
Cooling Towers2.00	Rolling2.00	
Forced Draft1.50	Tube2.00	

Item (UPC) Numbers And Quick Delivery Standards—“D” Series

JOINT SIZE	1	2	3	4	5	6	7	8	10	11	12	13	14
*P" Dimension	0.25	0.31	0.38	0.44	0.50	0.56	0.56	0.56	0.63	0.75	0.75	1.00	1.38
Set Screw Size	6-32	6-32	6-32	8-32	8-32	10-24	10-24	1/4-20	1/4-20	5/16-18	5/16-18	3/8-16	3/8-16
Pin Hole	.065/.061	.097/.093	.097/.093	.129/.124	.160/.155	.160/.155	.192/.185	.192/.185	.256/.247	.256/.247	.319/.308	.383/.370	.510/.493
Unassemb (Solid) UJ	15672	15685	15741	15767	15792	15834	15864	15913	15972	16016	16065	16113	16146
BORE KWY													
Solid —	15661*	15674*	15718*	15744*	15774*	15809*	15841*	15866*	15919*	15981*	16019*	16072*	16117*
1/16 No kwy	56704	56706	A	A	A	A	A	A
1/8 No kwy	56705	56707	56708	A	A	A	A	A
3/16 No kwy	16226*	46322	56709	56710	A	A	A	A	A
1/4 No kwy	A	16235*	47532	56711	56713	A	A	A	A
5/16 No kwy	A	16259*	47815	56714	56716	A	A	A
3/8 No kwy	A	A	16289*	56715	55818	56718	A	A	A
3/8 1/8 x 1/16	A	49452	56849	56850	56851	A	A	A
7/16 No kwy	A	56712	16346*	56717	56719	A	A	A
1/2 No kwy	A	A	44765	16363*	51881	56721	A	A
1/2 1/8 x 1/16	N/A	45471	44126*	48598	56722	A	A
9/16 No kwy	A	A	46915	16431*	56723	A	A	A
9/16 1/8 x 1/16	N/A	N/A	A	56720	56724	A	A	A
5/8 No kwy	A	A	A	45190	16479*	56727	A	A
5/8 3/16 x 3/32	N/A	N/A	N/A	44286	45304*	49202	A	A
11/16 No kwy	A	A	A	56725	56728	A	A	A
11/16 3/16 x 3/32	N/A	N/A	N/A	56726	56729	A	A	A
3/4 No kwy	A	A	A	16595*	44264	A	A
3/4 3/16 x 3/32	N/A	N/A	A	44055*	56732	A	A
13/16 No kwy	A	A	56730	56733	A	A
13/16 3/16 x 3/32	N/A	N/A	56731	56734	A	A
7/8 No kwy	A	A	A	16698*	56737	A	A
7/8 3/16 x 3/32	N/A	N/A	A	44312	56738	A	A
15/16 No kwy	A	A	56735	56739	A	A
15/16 1/4 x 1/8	N/A	N/A	56736	56740	A	A
1 No kwy	A	A	A	16753*	51252	A
1 1/4 x 1/8	N/A	N/A	A	44398*	51340	A
1-1/16 No kwy	A	A	56741	56743	A
1-1/16 1/4 x 1/8	N/A	N/A	56742	56744	A
1-1/8 No kwy	A	A	A	50076	A
1-1/8 1/4 x 1/8	N/A	N/A	A	56745	A
1-3/16 No kwy	A	A	56279	A
1-3/16 1/4 x 1/8	N/A	A	56746	A
1-1/4 No kwy	A	A	16841*	47149
1-1/4 1/4 x 1/8	N/A	N/A	44603	56750
1-5/16 No kwy	A	47845	56751
1-5/16 5/16 x 5/32	N/A	56747	56752
1-3/8 No kwy	A	56748	56753
1-3/8 5/16 x 5/32	N/A	56749	56754
1-7/16 No kwy	A	44383	56280
1-7/16 3/8 x 3/16	N/A	46665	56755
1-1/2 No kwy	A	A	16933*
1-1/2 3/8 x 3/16	N/A	A	50285
1-9/16 No kwy	A	56756
1-9/16 3/8 x 3/16	N/A	56757
1-5/8 No kwy	A	56758
1-5/8 3/8 x 3/16	N/A	56759
1-11/16 No kwy	A	56760
1-11/16 3/8 x 3/16	N/A	56761
1-3/4 No kwy	A	A
1-3/4 3/8 x 3/16	N/A	A
1-13/16 No kwy	A
1-13/16 1/2 x 1/4	A
1-7/8 No kwy	A
1-7/8 1/2 x 1/4	N/A
1-15/16 No kwy	A
1-15/16 1/2 x 1/4	N/A
2 No kwy	A
2 1/2 x 1/4	N/A

- Notes:**
- * indicates standard stock item. ("D" type only for bore and keyway.)
 - Shaded blocks indicate that it qualifies for quick delivery program.
 - A indicates available but extended lead time. N/A indicates not available.



D Type

A standard industrial-type universal joint with pin & block design, the D Type is ideal for applications with angles up to 25° and speeds up to 1750 RPM.¹ It is available with your choice of round, hex, splined, or keyway bores. Boot retaining grooves are standard. See page UJ-10 for selection of on-site replaceable universal joint boots. (Boots and lubricant extend U-joint life.)



D TYPE

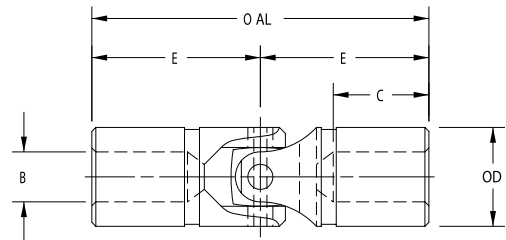

HD Type

The HD Type is a high quality universal joint made to exacting tolerances — perfect for your toughest high angle, high RPM applications. Precision machining, hardened yokes and matched fitting of all components means that it normally provides at least twice the life of a standard industrial-type universal joint. HDD and HDDX drive line assemblies can also be provided to increase the life of your drive line or drive shaft. These are available with your choice of round, hex, splined, or keyway bores. Boot retaining grooves are standard. (Boots and lubricant will extend U-joint life).

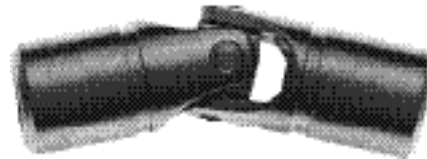

HD TYPE

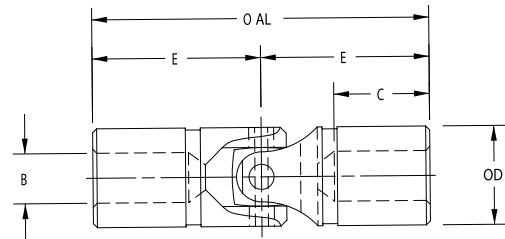

D & HD Type Dimensional Data

U-joint Size		Std. in	Max. Bore No Keyway		Max. Bore with Keyway		Max. Square/Hex Hole ³		OD in	OAL in	Bore Depth		Static* Breaking Torque		Weight lbs	
Solid	Bored		in	in	mm	in	mm	in			mm	C	E	in-lb	Nm	Solid
D-1	D-1B	.19	.25	619	4	.38	1.75	.56	.88	110	12	.05	.04
D-2	D-2B	.25	.38	925	6	.50	2.00	.62	1.00	378	42	.10	.08
D-3	D-3B	.31	.50	12	.25	6	.31	8	.62	2.25	.68	1.12	540	61	.17	.15
D-4	D-4B	.38	.62	15	.44	11	.38	9	.75	2.68	.88	1.34	768	86	.30	.25
D-5	D-5B	.44	.69	17	.50	12	.44	11	.88	3.00	.88	1.50	1,176	132	.45	.37
D-6	D-6B	.50	.75	19	.56	13	.50	12	1.00	3.38	1.00	1.68	1,560	176	.65	.55
D-7	D-7B	.56	.88	22	.62	15	.56	14	1.12	3.50	1.00	1.75	2,880	325	.85	.71
D-8	D-8B	.62	1.00	25	.75	18	.62	15	1.25	3.75	1.06	1.88	5,220	589	1.11	.94
D-10	D-10B	.75	1.12	28	.88	21	.75	19	1.50	4.25	1.18	2.12	7,920	895	1.80	1.50
D-11	D-11B	.88	1.25	31	1.00	25	.88	22	1.75	5.00	1.38	2.50	10,680	1,206	3.00	2.50
D-12	D-12B	1.00	1.50	38	1.19	30	1.00	25	2.00	5.44	1.50	2.72	15,600	1,762	4.20	3.50
D-13	D-13B	1.25	1.75	44	1.50	39	1.12	28	2.50	7.00	2.00	3.50	33,120	3,742	8.50	7.20
D-14	D-14B	1.50	2.00	50	1.81	48	1.38	35	3.00	9.06	2.75	4.53	65,400	7,389	16.00	13.00

- Notes:**
1. Operation of all universal joints is determined by the angle/speed combinations of the application. Consult Lovejoy Engineering for specific limitations and recommendations.
 2. Applications that fall outside the limitations of these tables should be referred to our technical design staff.
 3. Square and hex bores are measured across the flats.
- *This is not a recommended operating torque.



D Type 303 Stainless

D Type universal joints are available in 303 stainless steel when contact with corrosive chemicals, exposure to corrosive atmosphere, or sanitation requirements are a factor. Stainless steel universal joints are available from stock in popular sizes 4, 6, 8, 10 and 12. (Other sizes are quantity dependent.) Available with your choice of round, hex, splined, or keyway bores. Boot retaining grooves are standard. (Boots and lubricant extend U-joint life). Contact Lovejoy Engineering if you have specific questions or requirements.



D-SS TYPE

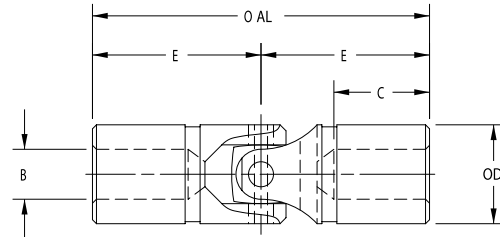

D Type 303 Dimensional Data

U-joint Size		Max. Bore			Max. Bore with Keyway		Max. Square/ Hex Hole ³		OD	OAL	Bore Depth		Static Breaking Torque		Weight lbs	
Solid	Bored	Std. in	No Keyway in	mm	in	mm	in	mm	in	in	C	E	in-lb	Nm	Solid	Bored
D-4SS	D-4SSB	.38	.62	15	.44	11	.38	9	.75	2.68	.88	1.34	512	58	.30	.25
D-6SS	D-6SSB	.50	.75	19	.56	13	.50	12	1.00	3.38	1.00	1.68	1,040	117	.65	.55
D-8SS	D-8SSB	.62	1.00	25	.75	18	.62	15	1.25	3.75	1.06	1.88	3,480	393	1.11	.94
D-10SS	D-10SSB	.75	1.12	28	.88	21	.75	19	1.50	4.25	1.18	2.12	5,280	597	1.80	1.50
D-12SS	D-12SSB	1.00	1.50	38	1.19	30	.88	22	2.00	5.44	1.50	2.72	10,400	1,175	4.20	3.50

- Notes:**
1. Maximum operating angle for transmission of power is 25°.
 2. Applications that fall outside the limitations of these tables should be referred to our technical design staff.
 3. Square and hex bore measured across the flats.
 4. Keyways, set screws, pin holes, or bores other than standard available at additional charge.

Needle Bearing Type

Designed with high quality, pre-lubricated and sealed needle bearings, this universal joint provides the reliability necessary for speeds up to 6000 RPM, and operating angles up to 25°. Needle bearing universal joints also ensure the precision required for robotics, instrumentation, control equipment, and many other demanding applications. Available in stock sizes 6, 8, 10 and 12 with your choice of round, hex, splined or keyway bores. Boot retaining grooves are standard. (Boots and lubricant extend U-joint life.)



NB TYPE

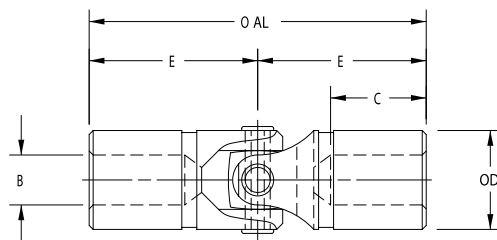

Needle Bearing Dimensional Data

U-joint Size		Max. Bore			Max. Bore with Keyway		Max. Square/ Hex Hole ³		OD	OAL	Bore Depth		Static Breaking Torque		Weight Solid lbs
Solid	Bored	Std. in	No Keyway in	mm	in	mm	in	mm	in	in	C	E	in-lb	Nm	Solid lbs
NB-6	NB-6B	.50	.75	19	.56	13	.50	12	1.00	3.38	1.00	1.68	1,150	130	.53
NB-8	NB-8B	.62	1.00	25	.75	18	.62	15	1.25	3.75	1.06	1.88	2,500	282	.91
NB-10	NB-10B	.75	1.12	28	.88	21	.75	19	1.50	4.25	1.25	2.12	4,400	497	1.50
NB-12	NB-12B	1.00	1.50	38	1.19	30	.88	22	2.00	5.44	1.62	2.72	10,500	1,186	3.40

- Notes:**
1. Maximum operating angle for transmission of power is 25°.
 2. For greater angular operation, use double U-joint. Join two U-Joints back to back and connect with a short shaft. Attach U-Joints to shaft by drilling and pinning.
 3. Square and hex bore measured across the flats.
 4. Swing Diameter is the maximum diameter over bearings. Clearance must be allowed.

Double Joint Arrangement

DD and DDX Types

Designed with two Lovejoy standard D type universal joints and a center connecting shaft tailored to your specific application requirements. This configuration compensates for both parallel misalignment and shaft separation. Spring-loaded assemblies, commonly used in multi-spindle drilling applications, are also available for quick removal, re-positioning, and replacement. Round, hex, splined, or keyway bores are supplied per your requirements. Use boots and lubricant to extend U-joint life.

GENERAL NOTE: In a double joint arrangement, the input and output speeds are near constant velocity.

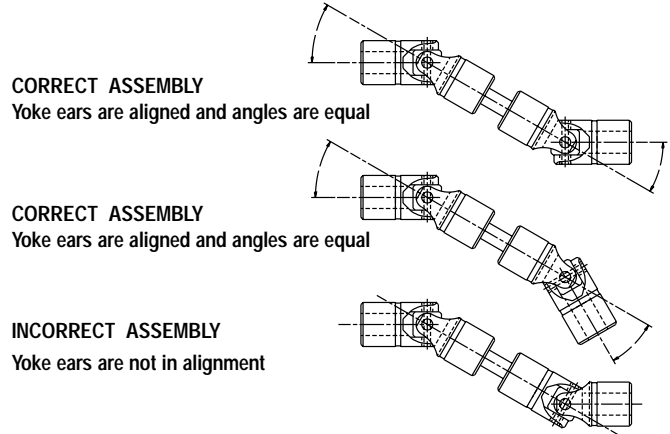
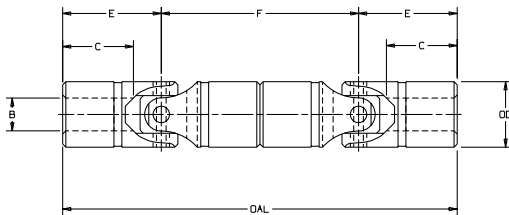
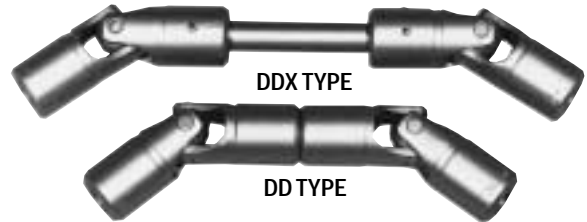

DD and DDX Type Universal Joints

Solid	U-joint Size		Max. Bore			Max. Square/Hex Hole ³				Bore Depth		Static Breaking Torque		DD Weight Solid lbs	
	Bored	Std.	in	No Keyway in	mm	Std.	Min.	in	mm	OD	OAL	C	E		in-lb
DD-1	DD-1B	.19	.25	6	1.75	1.18	.19	4	.38	3.50	.56	.88	110	12.4	.09
DD-2	DD-2B	.25	.38	9	2.00	1.38	.25	6	.50	4.00	.62	1.00	378	42.7	.18
DD-3	DD-3B	.31	.50	12	2.25	1.56	.31	7	.62	4.50	.68	1.12	540	61.0	.32
DD-4	DD-4B	.38	.62	15	2.68	1.81	.38	9	.75	5.38	.88	1.34	768	86.8	.55
DD-5	DD-5B	.44	.69	17	3.00	2.12	.44	11	.88	6.00	.88	1.50	1,176	133	.82
DD-6	DD-6B	.50	.75	19	3.38	2.38	.50	12	1.00	6.75	1.00	1.68	1,560	176	1.20
DD-7	DD-7B	.56	.88	22	3.50	2.50	.56	14	1.12	7.00	1.00	1.75	2,880	325	1.56
DD-8	DD-8B	.62	1.00	25	3.75	2.68	.62	15	1.25	7.50	1.06	1.88	5,220	590	2.05
DD-10	DD-10B	.75	1.12	28	4.25	3.06	.75	19	1.50	8.50	1.18	2.12	7,920	895	3.3
DD-11	DD-11B	.88	1.25	31	5.00	3.62	.81	20	1.75	10.00	1.38	2.50	10,680	1207	5.5
DD-12	DD-12B	1.00	1.50	38	5.44	3.94	.88	22	2.00	10.88	1.50	2.72	15,600	1762	7.7
DD-13	DD-13B	1.25	1.75	44	7.00	5.00	1.12	28	2.50	14.00	2.00	3.50	33,120	3742	15.7
DD-14	DD-14B	1.50	2.00	50	9.06	6.31	1.38	35	3.00	18.12	2.75	4.53	65,400	7389	29.0

- Notes:**
- Bores other than shown are available at additional charge. Dimensions subject to change without notice.
 - Shorter centers upon request.
 - Square and hex bore measured across the flats.
 - For J1 and J2 dimensions, see pg. UJ-10.

MULTI-SPINDLE

Multi-spindle assemblies consist of two universal joints mounted at opposite ends of a spring loaded sliding shaft. Used in drill heads where the universal joint is mounted between the driver and spindle, they compensate for parallel misalignment and varying centerlines. (High angle, high torque and high RPM can considerably shorten the life of the joints).

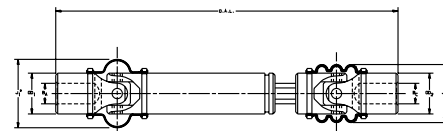

UPPER JOINT

LOWER JOINT

To ensure long life, the assemblies are built with HD series universal joints. The life is also extended if the universal joint is lubricated constantly. Flexible lubricant boots resist cracking, retain lubricant, and keep dirt and contaminants out.

Refer to Lovejoy Engineering for specific multi-spindle data for your application.

Pin & Block Types

LOJ and JR-4 Types

These economical universal joints have an offset pin design. They are ideal for use on hand operated, low torque drives such as remote control linkages, snow blowers (and other outdoor equipment), packaging machinery, awning devices, and much more. Capable of operating angles up to 45°.

LOJ: Available with round, hex, splined or keyway bores.

JR-4: Made of tough Zytel® material. Will not rust. No lubrication needed.

Withstands oils, gasoline, salts, temperatures from -40° to +225° F.

Available with .38" bore only.



LOJ TYPE

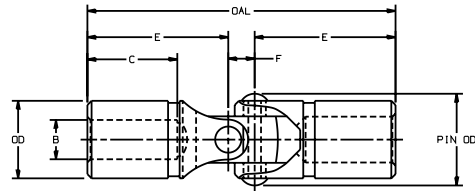

LOJ -JR-4

LOJ Type Dimensional Data

U-joint Size		Max. Bore			Max. Bore with Keyway		Pin OD in	OD in	OAL in	Bore Depth		Static Breaking Torque		Weight lbs	
Solid	Bored	Std.	in	mm	in	mm				C	F	in-lb	Nm	Solid	Bored
LOJ-6	LOJ-6B	.50	.62	15	.44	11	.88	.75	2.94	.75	.25	840 in-lb	95 Nm	.30	.25
LOJ-8	LOJ-8B	.62	.75	19	.56	14	1.12	1.00	3.68	.91	.31	1,500 in-lb	169 Nm	.65	.55
LOJ-10	LOJ-10B	.75	1.00	25	.75	19	1.44	1.25	3.75	1.00	.38	3,480 in-lb	393 Nm	1.11	.94

Note: Maximum operating angle 45° for hand-operated applications.

JR-4 Type Dimensional Data

U-joint Size	Bore Std. inch		Pin OD in	OD in	OAL in	Static Breaking Torque	
	C	F				in-lb	Nm
JR-4	.38	.62	1.18	.68	3.00	180 in-lb	20 Nm

Note: Maximum operating angle 45° for hand-operated applications.

Boot Dimensional Data

Universal Joint Boots

Lubrication is recommended for universal joints. When a universal joint is booted, wear areas of the universal joint are protected from dirt and contaminants, while lubrication is retained. Lovejoy on-site replaceable boots ensure proper lubrication for up to five times longer universal joint life. Installation and replacement is fast and easy, so your machine can be back in operation in minutes. Lovejoy universal joints D, D-SS, DD, DDX, HD and NB come pre-grooved.

When possible, use the larger diameter Upper Type boots. If sufficient space is not available, then use the smaller diameter Lower Type boots. Standard boots are packaged two to a bag.

Boot Size	OD	Upper J ₁	Lower J ₂
D-1	.38	.72	.62
D-2	.50	.91	.75
D-3	.62	1.09	.94
D-4	.75	1.34	1.06
D-5	.88	1.50	1.25
D-6	1.00	1.75	1.38
D-7	1.12	2.03	1.50
D-8	1.25	2.03	1.68
D-10	1.50	2.56	1.94
D-11	1.75	...	2.18
D-12	2.00	...	2.59
D-13	2.50	...	3.25
D-14	3.00	...	4.25



UNIVERSAL JOINT BOOTS

Note: Boot sizes D-11 through D-15 have 3-hump design similar to Lower Type Boot (L). Not shown.

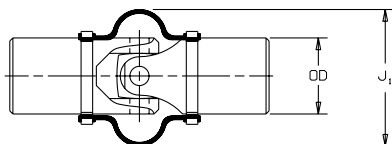

UPPER TYPE BOOT (U)

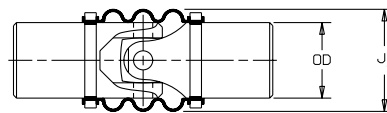

LOWER TYPE BOOT (L)